



DATA SHEET:

Poli-Sun

Poli-Sun is a sustainable 4 in 1 solar driven luminaire from Suncil®. It contributes to transforming urban spaces into sustainable, comfortable, recognizable and identifiable places.

FEATURES:

- » Stand alone solar powered LED luminaries
- » Solar, light, battery and grid tie – 4 in 1 solution
- » 5 asymmetrical optics solutions
- » Up to 12.400 lumens output
- » Battery internal and external optional Integration of sensor and Smart City functions
- » Intelligent Control Management System
- » Controllable via mobile app or web-platform
- » Light in areas where cabling is not available or feasible
- » No need for cabling and excavation cost

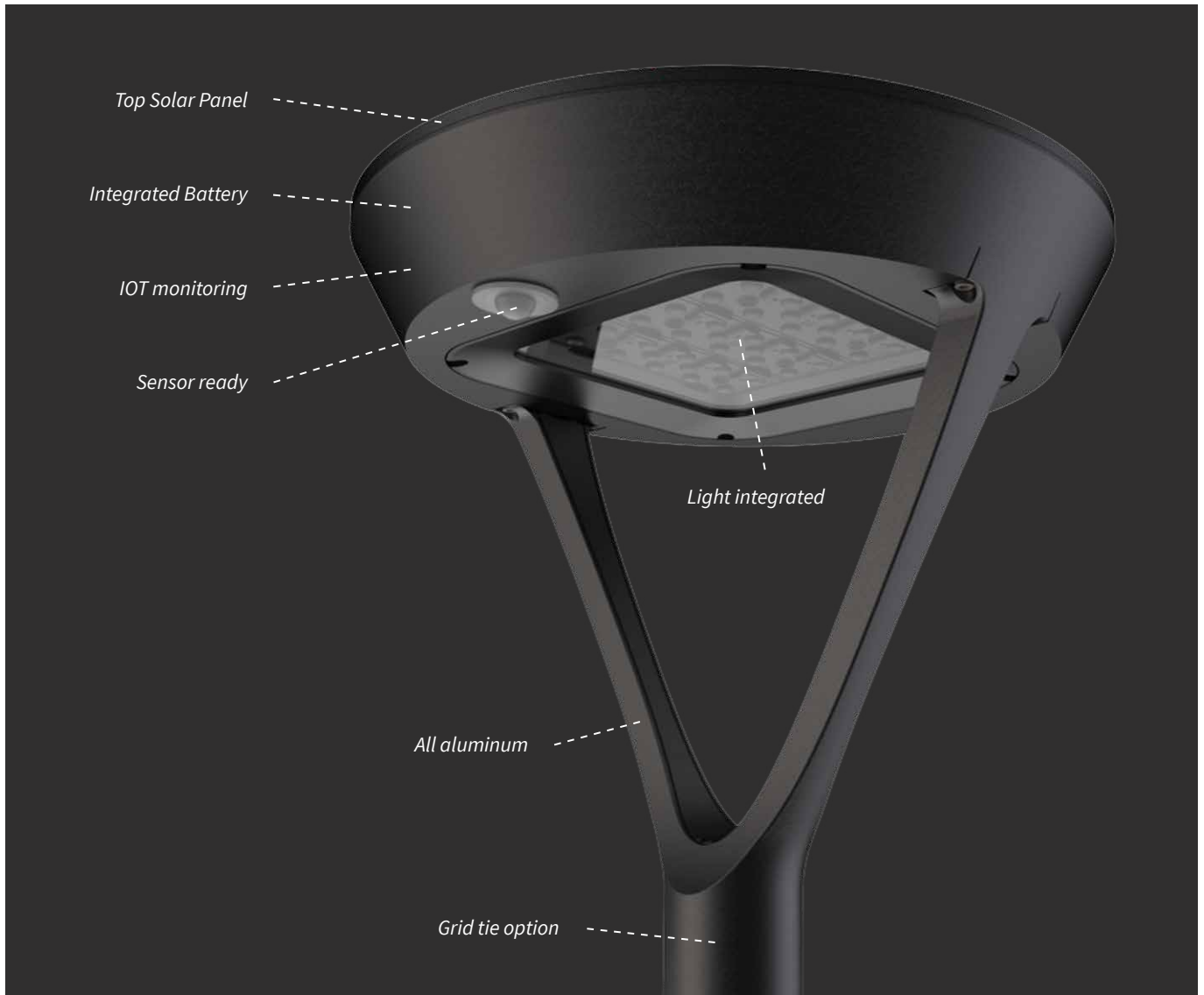

SOLAR

30Wp panel including 12 pcs. Cutted mono crystalline solar cells with anti-reflectioncoating that converts the maximum of light into energy. The structured glass surface reduces reflection, resists wind and snow weather conditions.

INTEGRATED BATTERY

240Wh, 3000 cycles LiFePO4 battery or optional with external battery connection up to 3450Wh.

SENSOR

A PIR motion sensor can be installed for energy saving and enabling light when people are present with a 4x4m coverage.

CONTROLLER

The controller maximizes the energy available from the solar panel and uses the energy to charge a battery. During the daytime the controller monitors the charged energy and handles charge up to 30W. When it gets dark the unit has counted the charged energy from the whole day. This energy is then used to light after sunset controlling the LED with up to 24W. The controller has an wireless access and can be connected to the SCADA system either through a gateway or GSM solution.

GRID-TIE

The luminaire can be connected to the grid as a hybrid solution, ensuring light at all times.

VISUAL COMFORT

Poli-Sun contributes to transforming urban spaces into comfortable, recognizable and identifiable places.

Thanks to the slight recessing of the optical surface, the product offers elevated visual comfort. The application of a decorative upper cover, with customizable colours, allows to further hide the light source from the view of the observer.

The reduced contrast of luminance guarantees a high visual well-being without altering the performance and the photometry of the product.

DIMENSIONS

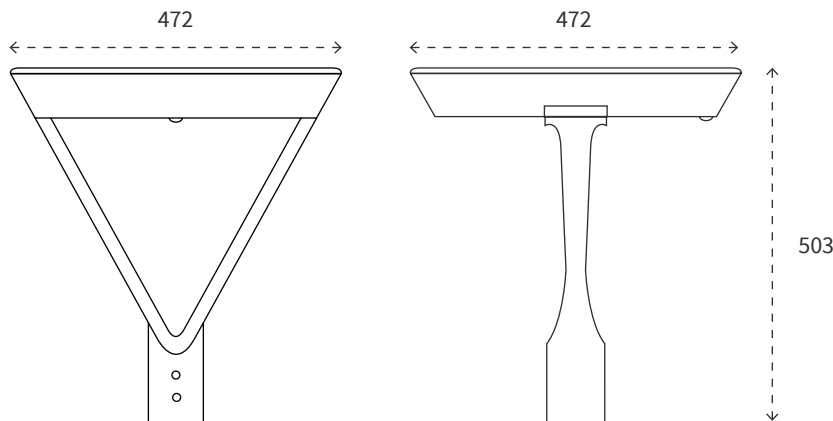

INTEGRATED BATTERY



Life cycle: 3000 LiFePO4
Size: 240Wh, external battery connection up to 3450Wh

GENERAL FEATURES

Description	Solar LED luminaire for streets and urban spaces
Insulation class	Class II
Nominal voltage	12,8V DC/220-240V 50/60Hz
Protection level	IP66
Protection against impact	IK06
Surge protection	10kV-10KA, type 3
Power factor	> 0,9
Ambient temperature	- 30 -> + 55 Degree Celsius
Weight	12 Kg
Maximum exposed surface	0,19 m ²
Lateral exposed surface	0,07 m ²
Intelligence	Driver and tele management controller included
Sensor	Motion / brightness detection optional
Warranty	5 years for LED fittings

MATERIALS

Body	Die-cast aluminium alloy UNI EN AB 47100
Screen	Tempered flat glass 5 mm
Lenses	PMMA high transparent
Fastening system	Die-cast aluminium alloy UNI En AB 47100
Seal	Expanded anti-age silicone foam
Screws	Stainless steel AISI 304
Finish	Phospho-chromatation and painting with polyester powder

INSTALLATION AND MAINTENANCE

Installation	Post top
Pole diameter	Ø60 mm (76 mm with accessory)
Wiring grid	Outgoing cable (L =200mm and a 2 pin plug and socket connector)
Wiring external battery	Outgoing cable (L =6m and a 2 pin plug and socket connector)
Wiring internal battery	None

OPTICAL SYSTEM

Source	LED R3
Colour temperture	2200,3000 & 4000 K
Colour rendering index(CRI)	70
Type of optics	Street asymmetrical ME-01, LT-06, LA-01, ST-01, RS-01
Optical units lifetime	>160.000h
Photobiological safety class	Exempt Group
ULOR	0%
DLOR	100%
Luminous intensity category	G*3
Luminous intensity up to	4205

POWER

PV	30WP monocrystalline cells in 4 mm flat tempered glass
Battery internal	240Wh 12,8V LiFePO4, 3000 cycles
Battery external	Size & type pending on geography
Driver power	1-36W output

APPROVALS

Normative framework	EN605981, EN60598-2-3, EN62471, EN61547
CE	EN55015, EN61000, EN61547, EN60598, EN62493

ASYMETRICAL OPTICS SOLUTION

Source flow	400 – 12400lm
Source power	2 – 72w
Colour rendering index (CRI)	≥ 70 (≥ 80)
Colour temperature (CCT)	2200 K / 3000 K / 4000 K
Photobiological safety class	Exempt group
Optical system	Multilayer optical system
ULOR – DLOR	0% – 100%
Classification	Cut off

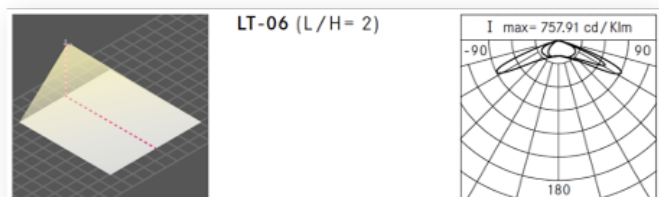
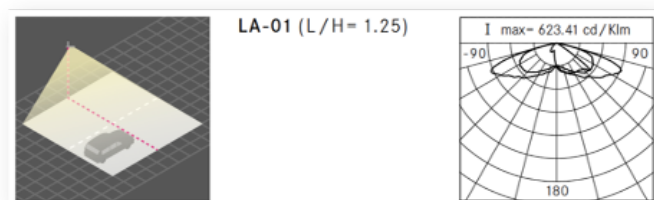
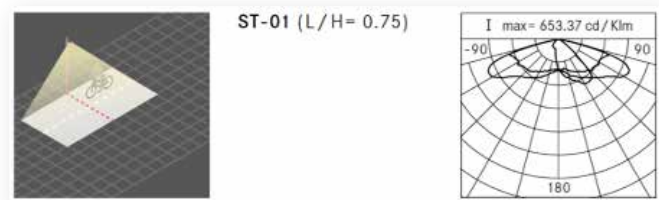
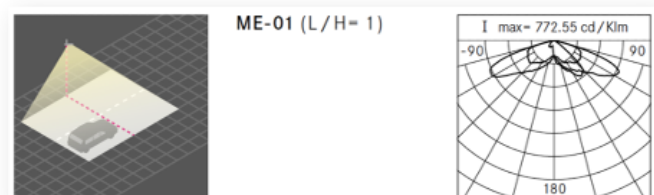
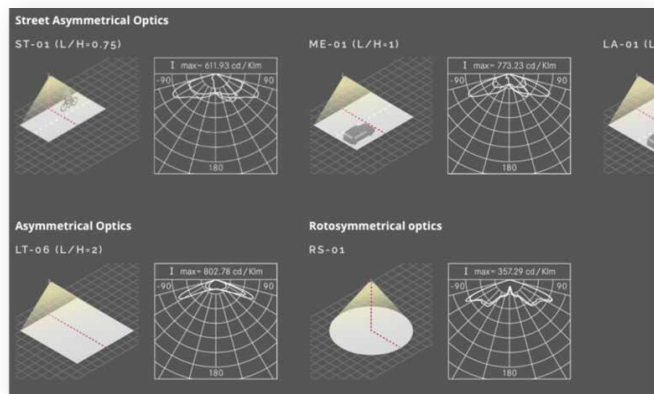
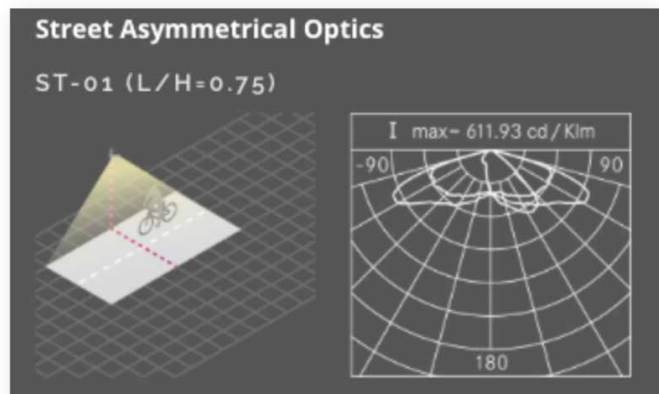

Please recycle to local guidelines

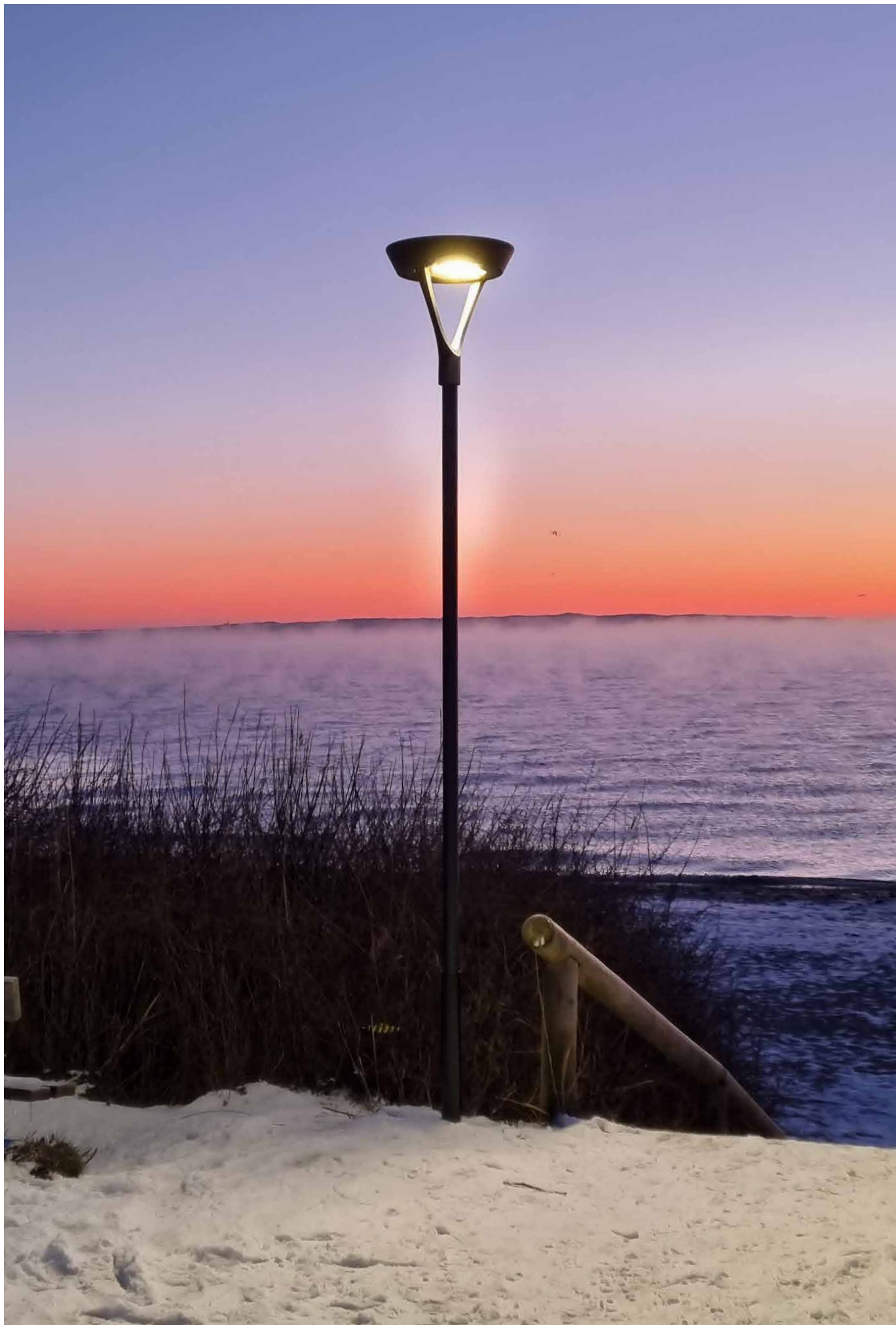

Inspired by Nature, **Powered by Sun**

Suncil® is a Danish based cleantech company, delivering smart city solar solutions for street lighting and infrastructure.

The company is born out of the notion that humanity has a responsibility to deliver a greener, safer and smarter world to our children's generation in order to secure a sustainable world.

We believe there is no time for sitting around, waiting for climate change to go away.

We need to take matters into our own hands and act now. This is the reason why we are working towards solving UN's 17 Sustainable World Goals as an integrated part of our business model.

Climate change cannot be solved solely by a single company. Governments, institutions and businesses need to work together, so our children can grow up in a brighter world.

Together, we create the future of tomorrow.

suncil.com
info@suncil.com
+45 53 63 53 70

Alsvej 21
8940 Randers SV, Denmark

suncil[®]
A MAKEEN ENERGY COMPANY