

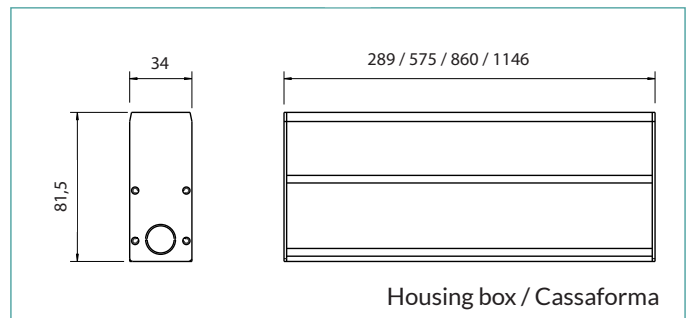

# SLASH 30

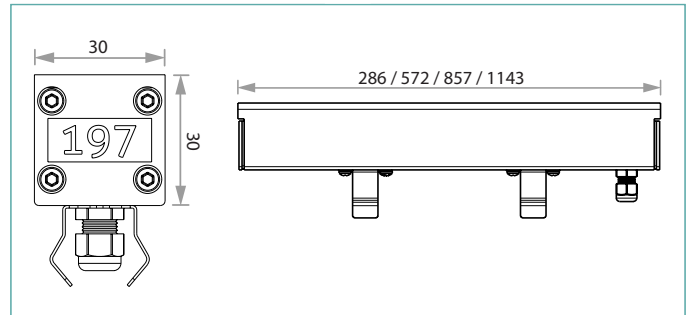

## DESCRIPTION

Slash 30 is made of extruded high quality anticorodal hard anodised aluminium and is designed for outdoor in-ground or surface mounted applications. It is available with 4 different optics including wall washing and wall grazing. The Slash 30 offers 2200K, 2700K, 3000K and 4000K as standard colour temperatures as well as RGBW and Tunable white. Glare control is further enhanced by the unique linear anti-glare louvre, which is especially designed for wall washing and grazing applications providing exceptional uniformity. A housing box is available for convenient and a continuous ground installation and adjustable brackets are available for a surface mounted installation.

## DESCRIZIONE

Lo Slash 30 è realizzato in alluminio estruso anticorodal anodizzato duro di alta qualità ed è progettato per applicazioni da esterno interrate o montate a superficie. È disponibile con 4 diverse ottiche tra cui wall washing e wall grazing. Slash 30 offre 2200K, 2700K, 3000K e 4000K come temperature di colore standard e RGBW e Tunable white. Il controllo dell'abbagliamento è ulteriormente potenziato dall'esclusivo frangiluce, appositamente progettato per l'illuminazione wall washing e le applicazioni wall grazing, garantendo un'illuminazione uniforme.

## OPTICS / OTTICHE:

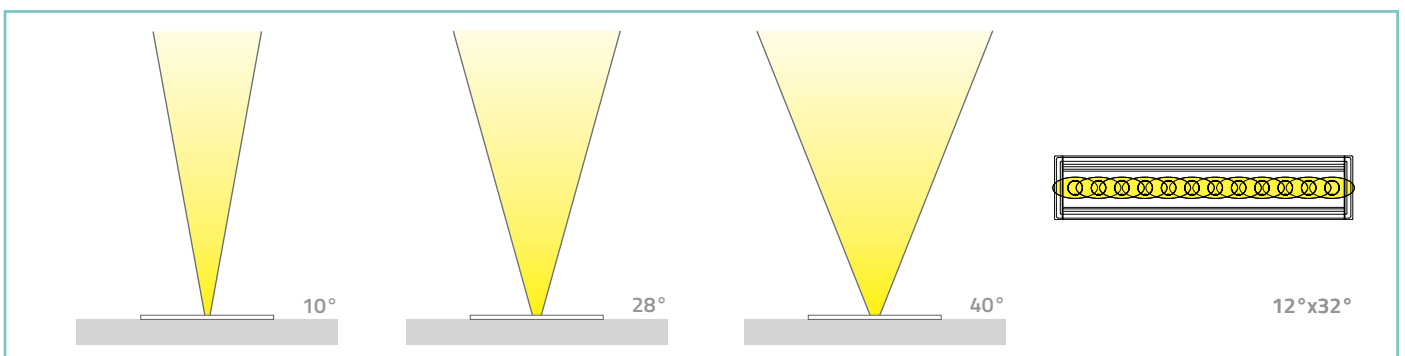



## SLASH 30



## TECHNICAL DATA / SCHEDA PRODOTTO:

Body:	Extruded aluminium	Corpo:	Alluminio estruso
Glass:	Extra clear tempered 4 mm	Vetro:	Vetro temperato extrachiaro 4 mm
Finishes:	Natural anodized	Finiture:	Anodizzato naturale
Installation:	Housing box / Fixing brackets	Fissaggio:	Cassaforma / Staffe di fissaggio
Power supply cables:	IP68 30Cm with Easy-Lock connector	Cavo di alimentazione:	IP68 30Cm con connettore Easy-Lock
Power supply:	Constant voltage 24Vdc	Alimentazione:	Constant voltage 24Vdc
Power consumption P5 1W:	6,4 W / 12,8 W / 19,2 W / 25,6 W	Potenza assorbita P05 1W:	6,4 W / 12,8 W / 19,2 W / 25,6 W
Lumenoutput P5 1W (source):	630 / 1260 / 1890 / 2520 lm (3000K)	Flusso luminoso P5 1W (sorgente):	630 / 1260 / 1890 / 2520 lm (3000K)
Power consumption P5 2W:	13,4 W / 26,8 W / 40,2 W / 53,6 W	Potenza assorbita P5 2W:	13,4 W / 26,8 W / 40,2 W / 53,6 W
Lumenoutput P5 2W (source):	1140 / 2280 / 3420 / 4560 lm (3000K)	Flusso luminoso P5 2W (sorgente):	1140 / 2280 / 3420 / 4560 lm (3000K)
Power consumption P10 1W:	3,5 W / 7 W / 10,5 W / 14 W	Potenza assorbita P10 1W:	3,5 W / 7 W / 10,5 W / 14 W
Lumenoutput P10 1W (source):	315 / 630 / 945 / 1260 lm (3000K)	Flusso luminoso P10 1W (source):	315 / 630 / 945 / 1260 lm (3000K)
Power consumption P10 2W:	7,1 W / 14,2 W / 21,3 W / 28,4 W	Potenza assorbita P10 2W:	7,1 W / 14,2 W / 21,3 W / 28,4 W
Lumenoutput P10 2W (source):	570 / 1140 / 1170 / 2280 lm (3000K)	Flusso luminoso P10 2W (source):	570 / 1140 / 1170 / 2280 lm (3000K)
Power consumption RGBW / TW:	11,6 W / 23,1 W / 34,7 W / 43,5 W	Potenza assorbita RGBW / TW:	11,6 W / 23,1 W / 34,7 W / 43,5 W
CRI:	> 90	CRI:	> 90
Bin selection:	Binning free 2 step MacAdam's	Selezione bin:	Binning free 2 step MacAdam's
Operating temperature:	-20°C +50°C	Temperatura di funzionamento:	-20°C +50°C
IP rating:	IP67	Grado di protezione:	IP67
Insulation class:	Class III	Classe d'isolamento:	Classe III
Impact resistance:	IK06	Protezione impatto:	IK06
Weight:	460 g / 880 g / 1,3 kg / 1,72 kg	Peso:	460 g / 880 g / 1,3 kg / 1,72 kg
Optics:	12° / 21° / 31° / 46° / 36°x13° 10° / 23° / 34° (RGBW - TW)	Ottiche:	12° / 21° / 31° / 46° / 36°x13° 10° / 23° / 34° (RGBW - TW)
LED colour temperature:	2200K / 2700K / 3000K / 4000K / RGBW / TW	Temperatura colore: LED	2200K / 2700K / 3000K / 4000K / RGBW / TW
Lifetime LED:	100000 hrs	Vita media LED:	100000 hrs
Photo biological risk:	RG0 / RG1	Rischio fotobiologico:	RG0 / RG1

## FINISHES / FINITURE:

 Natural anodized  
Anodizzato naturale



# SLASH 30



## PHOTOMETRICS / CURVE FOTOMETRICHE:

12°- P05 - 13,4W

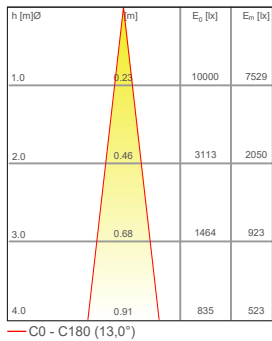

21°- P05 - 13,4W

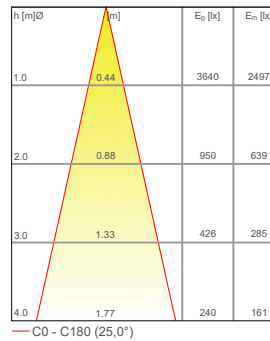

31°- P05 - 13,4W

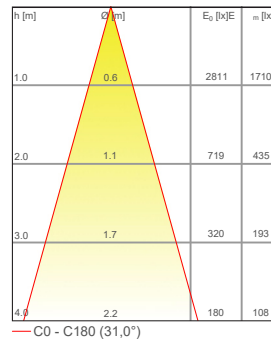

46°- P05 - 13,4W

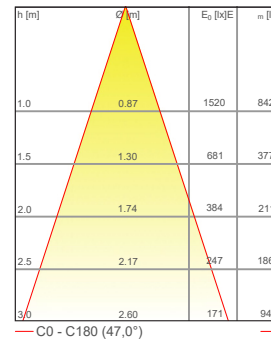

36° x 13°- P05 - 13,4W

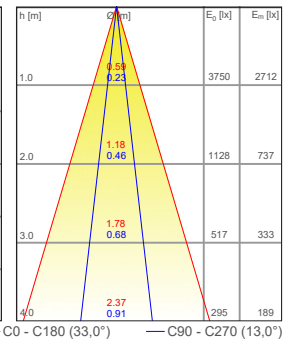

## PRODUCT CODE / CODICE PRODOTTO:

### SLA30P5 = SLASH 30 P5



Select one component from each column to specify a complete configuration:  
Selezionare un componente per ogni colonna per la configurazione completa:

LED colour / Colore LED	Optics / Ottiche	Finish / Finiture	Length/Lunghezza - Power / Potenza
22 = 2200K	N = 12°	07 = Natural anodized / Anodizzato naturale	0286 = 286 mm - 06 = 6,4 W / 13 = 13,4 W
27 = 2700K	M = 21°		0572 = 572 mm - 12 = 12,8 W / 26 = 26,8 W
30 = 3000K	W = 31°		0857 = 857 mm - 19 = 19,2 W / 40 = 40,2 W
40 = 4000K	F = 46°		1143 = 1143 mm - 25 = 25,6 W / 53 = 53,6 W
	E = 36°x13°		

Standard configuration example/  
Esempio di configurazione standard:

**SLA30P5.30.M.07.0572** Slash 30 P5 3000K 21°optics Natural anodized / Anodizzato naturale 572mm

### SLA30P10 = SLASH 30 P10



Select one component from each column to specify a complete configuration:  
Selezionare un componente per ogni colonna per la configurazione completa:

LED colour / Colore LED	Optics / Ottiche	Finish / Finiture	Length/Lunghezza - Power / Potenza
22 = 2200K	N = 12°	07 = Natural anodized / Anodizzato naturale	0286 = 286 mm - 03 = 3,5 W / 07 = 7,1 W
27 = 2700K	M = 21°		0572 = 572 mm - 07 = 7 W / 14 = 14,2 W
30 = 3000K	W = 31°		0857 = 857 mm - 10 = 10,5 W / 21 = 21,3 W
40 = 4000K	F = 46°		1143 = 1143 mm - 14 = 14 W / 28 = 28,4 W
	E = 36°x13°		

Standard configuration example/  
Esempio di configurazione standard:

**SLA30P10.30.M.07.0572** Slash 30 P10 3000K 21°optics Natural anodized / Anodizzato naturale 572mm

### SLA30 = SLASH 30 RGBW



Select one component from each column to specify a complete configuration:  
Selezionare un componente per ogni colonna per la configurazione completa:

LED colour / Colore LED	Optics / Ottiche	Finish / Finiture	Length/Lunghezza - Power / Potenza
FC = RGBW	N = 10°	07 = Natural anodized / Anodizzato naturale	0286 = 286 mm - 14 = 14 W
	M = 23°		0572 = 572 mm - 28 = 28 W
	W = 34°		0857 = 857 mm - 42 = 42 W
			1143 = 1143 mm - 56 = 56 W

Standard configuration example/  
Esempio di configurazione standard:

**SLA30.FC.M.07.0572** Slash 30 RGBW 3000K 23°optics Natural anodized / Anodizzato naturale 572mm

### SLA30 = SLASH 30 TW



Select one component from each column to specify a complete configuration:  
Selezionare un componente per ogni colonna per la configurazione completa:

LED colour / Colore LED	Optics / Ottiche	Finish / Finiture	Length/Lunghezza - Power / Potenza
TW = Tunable white	N = 10°	07 = Natural anodized / Anodizzato naturale	0286 = 286 mm - 14 = 14 W
	M = 23°		0572 = 572 mm - 28 = 28 W
	W = 34°		0857 = 857 mm - 42 = 42 W
			1143 = 1143 mm - 56 = 56 W

Standard configuration example/  
Esempio di configurazione standard:

**SLA30.TW.M.07.0572** Slash 30 TW 3000K 23°optics Natural anodized / Anodizzato naturale 572mm

# SLASH 30

## POWER SUPPLIES 24Vdc CONSTANT VOLTAGE / ALIMENTATORE TENSIONE COSTANTE 24Vdc:

On / Off

Code / Codice	Input	I Out	V Out	Watt	IP
PSU.CX.004	110÷240V / 50/60 Hz	0,9 A	24Vdc	20	IP20
PSU.CV.005	90÷305V / 47/63 Hz	1 A	24Vdc	25	IP67
PSU.CV.006	90÷305V / 47/63 Hz	2,5 A	24Vdc	60	IP67
PSU.CV.007	90÷305V / 47/63 Hz	3,75 A	24Vdc	90	IP67
PSU.CV.021	90÷305V / 47/63 Hz	10 A	24Vdc	240	IP 67

Control gear / Elettronica di controllo Slash 30 P5 1143mm 53,6 W

Code / Codice	Input	I Out	V Out	Watt	IP	#Slash 30
CGE.004 - 0/1-10V	24Vdc	6,5 A	24Vdc	156	IP20	Max 2
CGE.017 - DALI	24Vdc	6,5 A	24Vdc	156	IP20	Max 2
CGE.017.IP - DALI	24Vdc	6,5 A	24Vdc	156	IP67	Max 2
CGE.020 - DMX	24Vdc	6,5 A	24Vdc	156	IP20	Max 2







Control gear / Elettronica di controllo Slash 30 P10 1143mm 28,4 W

Code / Codice	Input	I Out	V Out	Watt	IP	#Slash 30
CGE.004 - 0/1-10V	24Vdc	6,5 A	24Vdc	156	IP20	Max 5
CGE.017 - DALI	24Vdc	6,5 A	24Vdc	156	IP20	Max 5
CGE.017.IP - DALI	24Vdc	6,5 A	24Vdc	156	IP67	Max 5
CGE.020 - DMX	24Vdc	6,5 A	24Vdc	156	IP20	Max 5

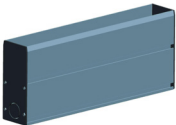
Control gear / Elettronica di controllo RGBW / TW 1143mm 56 W

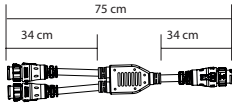
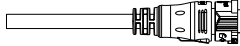
Code / Codice	Input	I Out	V Out	Watt	IP	#Slash 30
CGE.016 - DALI RGBW / TW	24Vdc	4x5 A	24Vdc	480	IP20	Max 8 m
CGE.019 - DMX RGBW / TW	24Vdc	4x5 A	24Vdc	480	IP20	Max 8 m

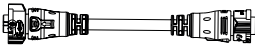
## ACCESSORIES / ACCESSORI

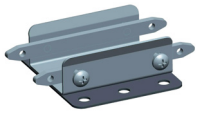
<p>HB.010.0289 (0,35kg) HB.010.0575 (0,70 kg) HB.010.0860 (0,96 kg) HB.010.1146 ( 1,38 kg)</p>  <p>Housing box Cassaforma</p>	 <p>ACC.130.0268 ACC.130.0554 ACC.130.0840 ACC.130.1126</p> <p>Anti-Glare louver Frangiluce</p>	 <p>Fixing bracket Staffe di fissaggio ACC.125</p>	 <p>Y connection cable Cavo di connessione a Y ACC.058</p>	
 <p>Head Cable 5m Cavo di testa 5m ACC.057</p>	 <p>Extension cable 1m Prolunga 1m ACC.059</p>	 <p>Extension cable 2m Prolunga 2m ACC.131</p>	 <p>Housing box alignment kit Kit di allineamento cassaforma ACC.093</p>	 <p>Housing box fixing kit Kit di fissaggio cassaforma ACC.094</p>