



# PILOT 120 S HV

TECHNICAL DATASHEET



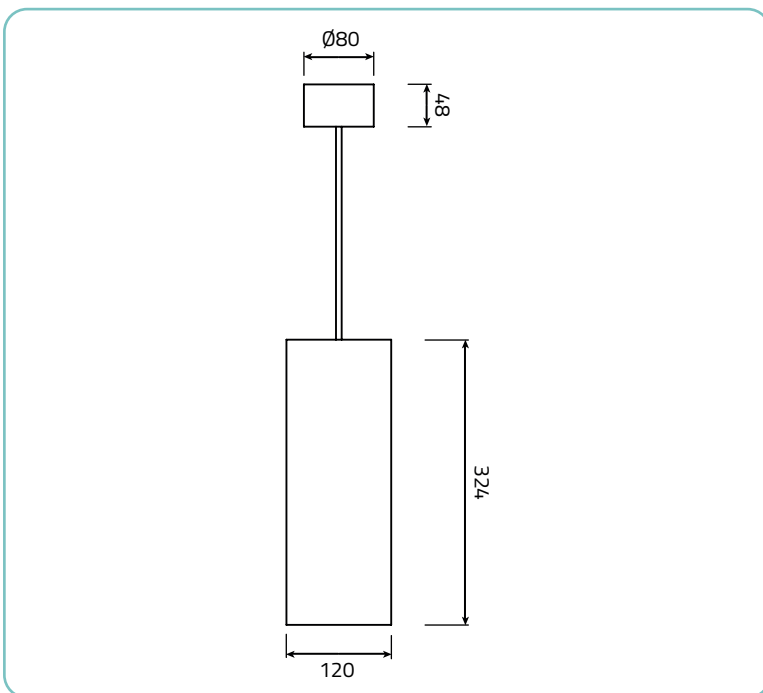

MADE IN ITALY

## TECHNICAL DRAWING



## FINISHES

-  White RAL 9003
-  Black RAL 9005
-  Flamed bronze

## PRODUCT CODE

P120SH = PILOT 120 S HV		Select one component from each column to specify a complete configuration:		
	LED colour	Optics	Finishes	Power
	27 = 2700K 30 = 3000K 40 = 4000K DW = Dim to Warm	N = 20° (DW) M = 32° W = 40° (DW)	01 = White RAL 9003 02 = Black RAL 9005 16 = Flamed bronze	16 = 16 Watt

Standard configuration example:

P120SH.27.N.01.CC | Pilot 120 - 2700K optics 20° white constant current

## TECHNICAL SHEET

LIGHTING CHARACTERISTICS	
CRI	>90
Lumenoutput (source)	1154 lm (3000K) / 1045 lm - 28 lm (DW)
Optics	20° / 32° / 40° / (20° / 40° DW)
LED colour temperature	2700K / 3000K / 4000K / (1800K-3000K DW)
LED lifetime	100000 hrs
Bin selection	Binning free 2 step MacAdam's
MECHANICAL CHARACTERISTICS	
Body	Aluminium
Finishes	White RAL 9003 / Black RAL 9005 / Flamed bronze
Installation	Suspension
Weight	1,830 kg
Dimensions	Ø120x324 mm
ELECTRICAL CHARACTERISTICS	
Power supply	110-277 Vac - 50/60Hz - dimmable DALI
Power consumption	16 Watt
GENERAL CHARACTERISTICS	
Power supply cables	300 cm PVC + PVC 5x0,5 mm <sup>2</sup>
Operating temperature	-20°C + 50°C
IP rating	IP20
Insulation class	Class I
Photobiological risk	RG0 / RG1

## ACCESSORIES



ACC.001 | Honeycomb louver



ACC.002 | Micro prismatic diffuser

OPTICS

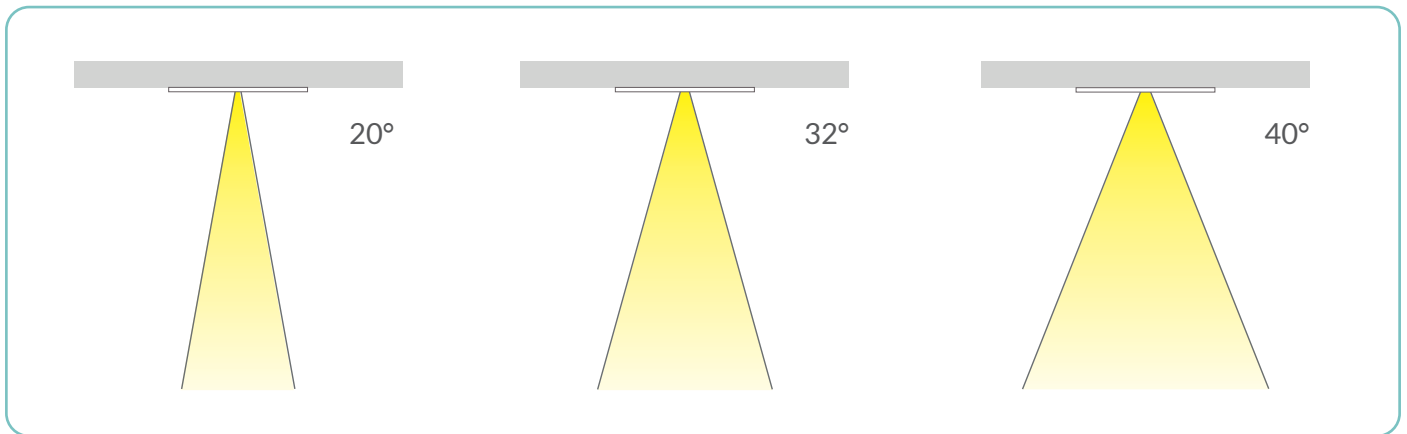

PHOTOMETRICS

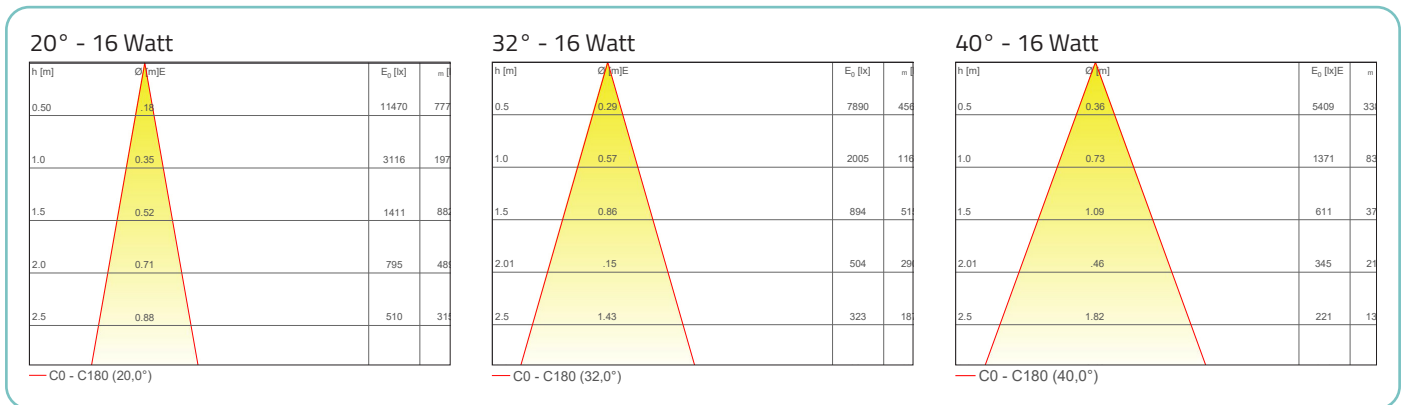

POLAR PLOT

